

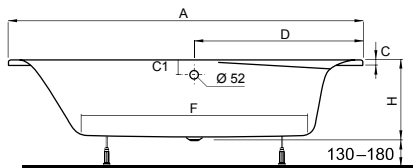

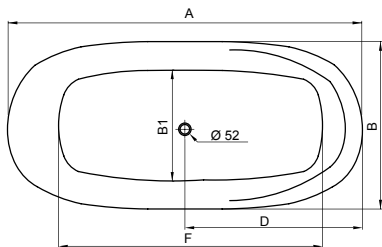

**KOLO**

(PL) Wanna owalna (BG) Овална вана (CZ) Oválná vana (EN) Oval bathtub (HU) Ovális kád (RO) Baie ovala  
 (RU) Ванна овальная (SK) Oválna vaňa (UA) Ванна овальна



		<b>A</b>	<b>B</b>	<b>B1</b>	<b>D</b>	<b>F</b>	<b>H</b>	<b>C</b>	<b>C1</b>		
PROGRESS	XWL2580	1800	850	550	855	1191	430	30	80	●	▲
CLARISSA	XWL2680	1800	850	550	900	1179	470	30	70	▲	▲

- - brak możliwości montażu / липса на възможност за монтаж/ montáž není možná/ no installation possible/ a szerelés nem lehetséges/ fără posibilități de montaj/ нет возможности монтажа/ nemožná montáž/ немає можливості замонтування
- ▲ - na długości długiego rantu/ по дължината на ръба/ po délce dlouhého okraje/ along the entire long edge/ a hosszú perem hosszúságában/ de-a lungul bordurii lungi/ на глибину борта/ po délke dlhého okraja/ на глибину борту

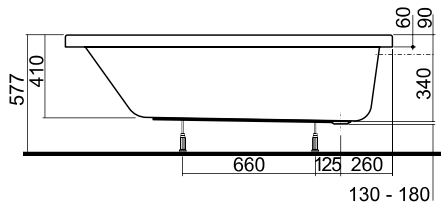
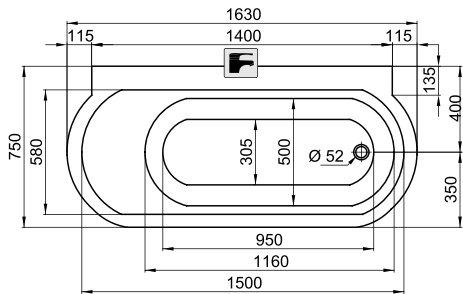

EGO

XWL0263

1630 x 750

KOLO



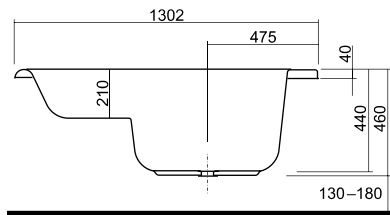
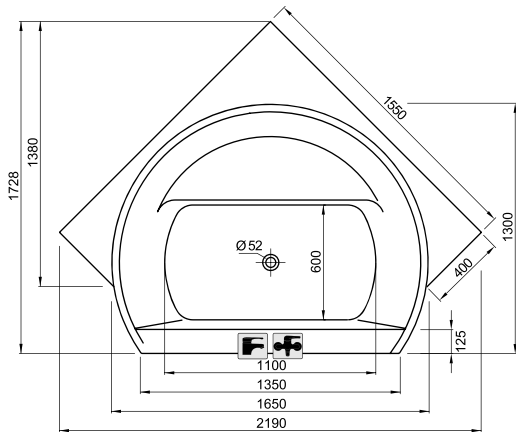

FURORA

XWLO465

1650 x 1300

(PL) Wanny narożne (BG) Ъглови вани (CZ) Rohové vany (EN) Corner bathtubs (HU) Sarokkádák (RO) Căzi de baie de colt  
 (RU) Ванны угловые (SK) Rohové vane (UA) Ванни кутові

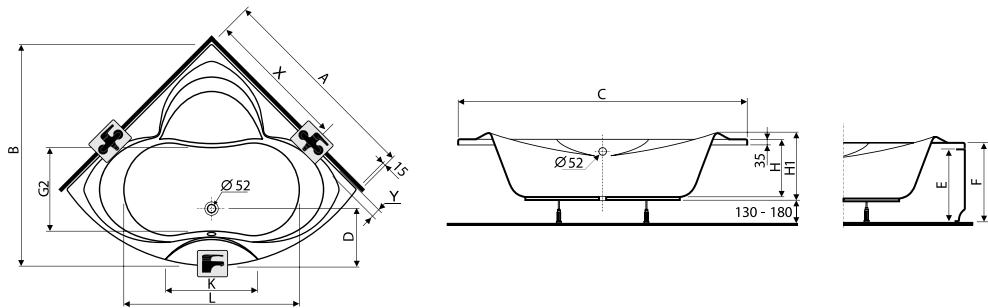

		<b>A</b>	<b>B</b>	<b>C</b>	<b>H</b>	<b>H1</b>	<b>D</b>	<b>E</b>	<b>F</b>	<b>K</b>	<b>L</b>	<b>G2</b>	<b>X</b>	<b>Y</b>
FAMILY	XWN0755	1550	1570	2183	460	480	330	590	625	-	1150	719	1100	80
MAXIMA	XWN0850	1500	1570	2110	450	470	340	580	615	-	1100	660	1120	30
REWIA	XWN0845	1450	1490	2040	450	470	330	580	615	-	1100	600	1070	30
SESJA	XWN0835	1350	1460	1900	450	470	350	570	605	-	1000	600	1000	30
NEO	XWN1025	1250	-	1760	420	450	265	520	555	-	1000	650	-	-
INSPIRATION*	XWN3040	1400	1400	1972	445	465	510	580	615	-	930	500	1000	70
RELAX*	XWN3050	1500	1500	2091	445	465	530	580	615	-	1100	540	1120	100



		A	B	C	H	H1	D	E	F	K	L	G2	X	Y
MAGNUM*	XWN3055	1550	1550	2187	460	480	515	580	630	-	926	730	770	35
SUPERO**	5414	1400	1505	1970	400	420	310	530	565	-	1050	920	1000	35
ACAPULCO**	5408	1200	1350	1665	360	380	360	480	515	-	1000	475	920	30
ACAPULCO**	5409	1300	1380	1800	360	380	370	480	515	-	1100	520	930	30
ACAPULCO**	5411	1400	1480	1980	380	400	340	570	605	-	1060	630	890	80

\* - Export

\*\* - DIY Poland

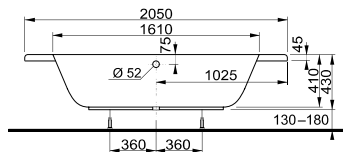
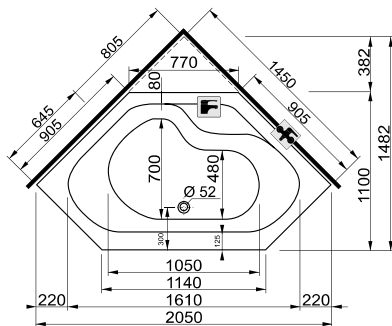

SERENADA

XWN2145

1450 x 1450

- (PL) Wanny asymetryczne (BG) Асиметрични вани (CZ) Asymetrické vany (EN) Asymmetrical bathtubs  
 (HU) Aszimmetrikus kádak (RO) Căzi de baie asimetrice (RU) Ванны ассиметричные (SK) Asymetrické vane  
 (UA) Ванни асиметричні

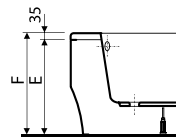
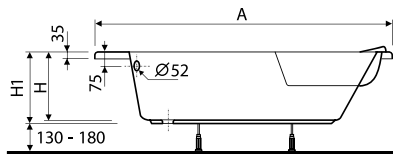
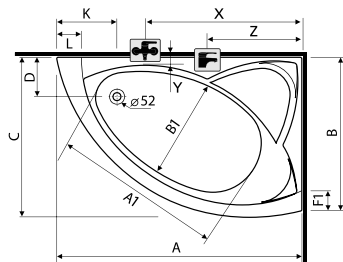

		A	B	A1	B1	C	H	H1	D	E	F	K	L	F1	X	Y	Z
CLARISSA (R)*	XWA0860	1600	1000	1065	500	-	450	470	330	580	615	310	-	100	1100	100	1100
CLARISSA (L)*	XWA0861	1600	1000	1065	500	-	450	470	330	580	615	310	-	100	1100	100	1100
CLARISSA (R)*	XWA0870	1700	1050	1150	545	-	450	470	330	580	615	310	-	100	1150	100	1150
CLARISSA (L)*	XWA0871	1700	1050	1150	545	-	450	470	330	580	615	310	-	100	1150	100	1150
ELIPSO (R)*	XWA0640	1400	1000	1000	565	-	440	460	300	570	605	270	-	60	900	60	920
ELIPSO (L)*	XWA0641	1400	1000	1000	565	-	440	460	300	570	605	270	-	60	900	60	920
ELIPSO (R)*	XWA0850	1500	1000	1050	570	-	440	460	300	570	605	270	-	60	1000	60	920
ELIPSO (L)*	XWA0851	1500	1000	1050	570	-	440	460	300	570	605	270	-	60	1000	60	920
ELIPSO (R)*	XWA0660	1600	1000	1150	550	-	440	460	300	570	605	270	-	60	1050	60	1020
ELIPSO (L)*	XWA0661	1600	1000	1150	550	-	440	460	300	570	605	270	-	60	1050	60	1020



		A	B	A1	B1	C	H	H1	D	E	F	K	L	F1	X	Y	Z
NEO PLUS (R)*	XWA0740	1400	1000	1000	540	1030	440	460	270	570	605	385	125	70	900	60	600
NEO PLUS (L)*	XWA0741	1400	1000	1000	540	1030	440	460	270	570	605	385	125	70	900	60	600
NEO PLUS (R)*	XWA0750	1500	1000	1050	560	1030	440	460	270	570	605	405	125	70	1050	60	600
NEO PLUS (L)*	XWA0751	1500	1000	1050	560	1030	440	460	270	570	605	405	125	70	1050	60	600
NEO PLUS (R)*	XWA0760	1600	1000	1100	623	1030	440	460	270	570	605	425	125	70	1100	60	660
NEO PLUS (L)*	XWA0761	1600	1000	1100	623	1030	440	460	270	570	605	425	125	70	1100	60	660
SUPERO** (R)*	5533	1450	850	1031	513	950	400	420	280	530	565	280	-	52	1050	52	◆
SUPERO** (L)*	5534	1450	850	1031	513	950	400	420	280	530	565	280	-	52	1050	52	◆
SUPERO** (R)*	5536	1500	1000	1150	624	-	400	420	275	530	565	260	-	60	1050	60	620
SUPERO** (L)*	5537	1500	1000	1150	624	-	400	420	275	530	565	260	-	60	1050	60	620
ACAPULCO** (R)*	5530	1450	1000	1091	516	1056	420	440	575	540	575	675	-	50	1050	30	580
ACAPULCO** (R)*	5531	1450	1000	1091	516	1056	420	440	575	540	575	675	-	50	1050	30	580
AGAT (R)*	XWA0950	1500	915	1074	637	1000	435	455	315	570	605	300	-	20	1020	20	◆
AGAT (L)*	XWA0951	1500	915	1074	637	1000	435	455	315	570	605	300	-	20	1020	20	◆
SPRING* (R)*	XWA3060	1600	1000	971	433	-	445	465	350	580	615	290	-	-	1120	-	◆
SPRING* (L)*	XWA3061	1600	1000	971	433	-	445	465	350	580	615	290	-	-	1120	-	◆
SPRING* (R)*	XWA3070	1700	1000	1200	577	-	445	465	350	580	615	290	-	-	1170	-	◆
SPRING* (L)*	XWA3071	1700	1000	1200	577	-	445	465	350	580	615	290	-	-	1170	-	◆
PROMISE* (R)*	XWA3050	1500	888	909	489	1000	445	465	350	580	615	350	52	60	1150	80	◆
PROMISE* (L)*	XWA3051	1500	888	909	489	1000	445	465	350	580	615	350	52	60	1150	80	◆

\* - Export

\*\* - DIY Poland

(R)\* - Prawa/ Дясна/ Pravé/ Right/ Jobbos/ Dreapta/ Правая/ Pravé/ Права

(L)\* - Lewa/ Лява/ Levé/ Left/ Balos/ Stinga/ Левая/ L'avé/ Ліва

◆ - w narożniku przy odpływie/ в ъгъла при сифона/ v rohu u odtoku/ in the corner by the outflow/ a sarokban a lefolyónál/ în colț la scurgere/ в углу над сифоном/ v rohu pri odtoku/ в куті над сифоном



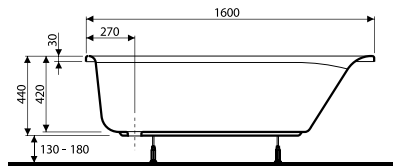
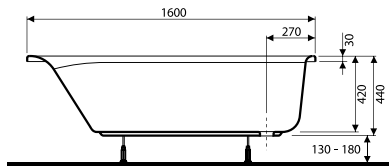
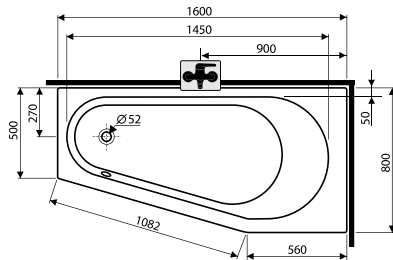
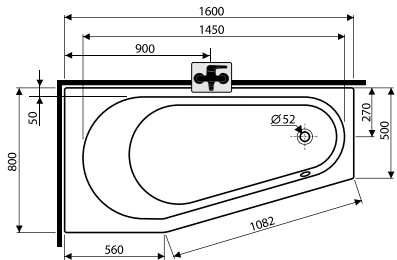

PASJA (L)\*

XWA2261

1600 x 800

PASJA (R)\*

XWA2161

1600 x 800

KOLO



(PL) Wanny prostokątne (BG) Правоъгълни вани (CZ) Pravoúhlé vany (EN) Rectangular bathtubs (HU) Klasszikus kádák  
 (RO) Căzi de baie dreptunghiulare (RU) Ванны прямоугольные (SK) Pravoúhlé vane (UA) Ванни прямокутні

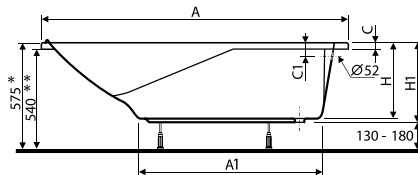
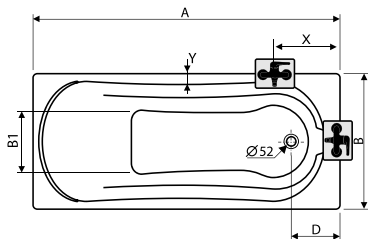

		<b>A</b>	<b>B</b>	<b>A1</b>	<b>B1</b>	<b>D</b>	<b>H</b>	<b>H1</b>	<b>C</b>	<b>C1</b>	<b>X</b>	<b>Y</b>	
CLARISSA	XWP2670	1700	750	1156	470	850	450	470	30	70	500	80	
	XWP2680	1800	800	1180	490	900	470	490	30	70	500	100	▲
	XWP2690	1900	900	1206	560	950	485	505	30	70	500	100	
PRIMO	XWP0840	1400	700	855	310	275	440	460	35	70	400	60	
	XWP0850	1500	700	912	310	275	440	460	35	70	400	60	
	XWP0860	1600	700	990	310	275	440	460	35	70	400	60	▲
	XWP0870	1700	700	1070	310	275	440	460	35	70	400	60	
MODO	XWP1160	1600	700	1120	460	280	450	470	35	70	500	80	
	XWP1170	1700	750	1185	510	280	450	470	35	70	500	80	
	XWP1171	1700	750	1085	467	280	450	470	35	70	500	80	◆
	XWP1181	1800	800	1185	517	280	450	470	35	70	500	80	

		<b>A</b>	<b>B</b>	<b>A1</b>	<b>B1</b>	<b>D</b>	<b>H</b>	<b>H1</b>	<b>C</b>	<b>C1</b>	<b>X</b>	<b>Y</b>	
PERFECT	XWP1040	1400	700	1000	460	270	435	455	35	70	400	60	
	XWP1050	1500	750	1075	510	270	435	455	35	70	400	60	
	XWP1060	1600	750	1150	510	270	435	455	35	70	400	60	▲
	XWP1070	1700	750	1225	510	270	435	455	35	70	400	60	
	XWP1080	1800	800	1300	560	270	435	455	35	70	400	60	
COMFORT	XWP0250	1500	750	950	370	270	420	440	35	75	400	55	
	XWP0260	1600	750	950	370	270	420	440	35	75	400	55	
	XWP0270	1700	750	980	370	270	420	440	35	75	400	55	◆
	XWP0280	1800	800	1150	420	270	420	440	35	75	400	55	
	XWP0290	1900	900	1150	450	270	420	440	35	75	400	65	
TEAM	XWP0078	1700	800	1100	560	850	435	465	35	70	850	30	▲
OPAL PLUS	XWP0840	1400	700	770	288	318	432	452	35	80	400	40	
	XWP0850	1500	700	956	288	318	432	452	35	80	400	40	▲
	XWP0860	1600	700	973	288	318	432	452	35	80	400	40	
	XWP0870	1700	700	1075	288	318	432	452	35	80	400	40	
SUPERO**	5340	1400	700	950	480	290	400	420	35	75	400-700	60	
	5341	1500	700	1050	480	290	400	420	35	75	400-750	60	
	5342	1600	700	1150	480	290	400	420	35	75	400-800	60	▲
	5343	1700	700	1250	480	290	400	420	35	75	400-850	60	
	5360	1600	750	1122	517	310	420	435	35	75	400-850	60	

▲ - na długości długiego rantu/ по дължината на ръба/ po délce dlouhého okraje/ along the entire long edge/ a hosszú perem hosszúságában/ de-a lungul bordurii lungi/ на глубину борта/ po délce dlhého okraja/ на глубину борту

◆ - w narożniku przy odpływie/ в ъгъла при сифона/ v rohu u odtoku/ in the corner by the outflow/ a sarokban a lefolyónál/ în colț la scurgere/ в углу над сифоном/ v rohu pri odtoku/ в куті над сифоном



		<b>A</b>	<b>B</b>	<b>A1</b>	<b>B1</b>	<b>D</b>	<b>H</b>	<b>H1</b>	<b>C</b>	<b>C1</b>	<b>X</b>	<b>Y</b>	
	5370	1400	700	950	350	220	360	400	35	75	400	55	
FORTE **	5371	1500	700	1000	350	220	360	400	35	75	400	55	
	5372	1600	700	1100	350	220	360	400	35	75	400	55	◆
	5373	1700	700	1170	350	220	360	400	35	75	400	55	
	5374	1700	750	1170	350	220	360	400	35	75	400	55	
	XWP3051	1500	700	970	380	270	370	390	35	75	400	40	
AQUALINO*	XWP3061	1600	700	990	380	270	370	390	35	75	400	40	◆
	XWP3071	1700	700	1020	380	270	370	390	35	75	400	40	

\* - Export

\*\* - DIY Poland

◆ - w narożniku przy odpływie/ в ъгъла при сифона/ v rohu u odtoku/ in the corner by the outflow/ a sarokban a lefolyónál/  
în colț la scurgere/ в углу над сифоном/ в куті над сифоном

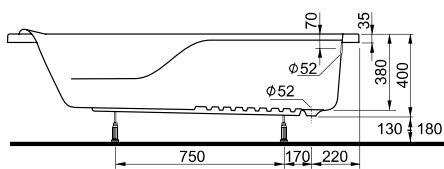
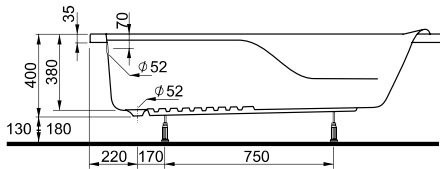
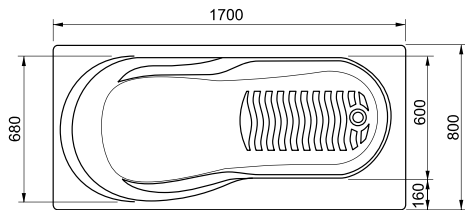
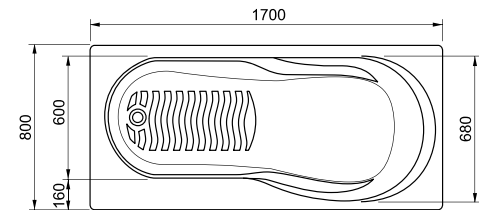

NOVA TOP      YWP0871 (R)\*      1700 x 800

NOVA TOP      YWP0872 (L)\*      1700 x 800

(R)\* - Права/ Дясна/ Pravé/ Right/ Jobbos/ Dreapta/ Правая/ Pravé/ Права

(L)\* - Lewa/ Лява/ Levé/ Left/ Balos/ Stinga/ Левая/ L'avé/ Ліва







**KOLO**

- (PL) Poręcz prosta (BG) Ръкохватка права  
 (CZ) Madlo jednoduché (EN) Handrail  
 (HU) Kapaskodó hossz (RO) Balustrada simpla  
 (RU) Поручень прямой (SK) Držadlo jednoduché  
 (UA) Прямий поручень

- (PL) Poręcz ścienna łukowa stała (BG) Ръкохватка стенна дъгообразна  
 (CZ) Pevné madlo k umyvadlu (EN) Bow-type handrail for wall mounting, fixed  
 (HU) Kapaskodó mellé, falra szerelhető, U alakú, rögzített (RO) Balustrada pe perete in forma (RU) Поручень настенный дугообразный неподвижный  
 (SK) Držadlo pevné s upevnením na stenu (UA) Поручень настінний дугоподібний нерухомий

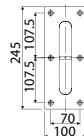
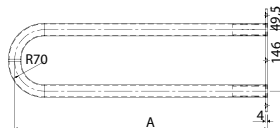
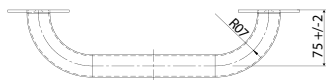
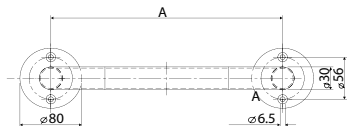

	<b>A</b>
L2100105	300
L2100605	600

	<b>A</b>
L2154605	600
L2154405	700



- (PL) Poręcz uchylna łukowa (BG) Раздвижна ръкохватка  
 (CZ) Sklopné madlo (EN) Bow-type handrail  
 (HU) Kihajtható kapaszkodó (RO) Suținere înclinată  
 (RU) Поручень настенный дугообразный подвижный  
 (SK) Sklopné držadlo (UA) Поручень настінний  
 дугоподібний рухомий

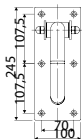
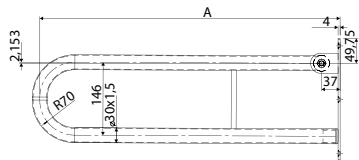

**A**

L2161205

600

L2161005

700

KOŁO



- (PL) Poręcz prosta (BG) Ръкохватка права  
 (CZ) Madlo jednoduché (EN) Handrail  
 (HU) Kapaszkodó hossz (RO) Balustrada simpla  
 (RU) Поручень прямой (SK) Držadlo jednoduché  
 (UA) Прямий поручень

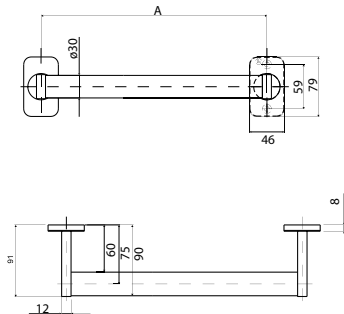

	<b>A</b>
L30003071	300
L30004071	400
L30006071	600
L30008071	800

- (PL) Poręcz kątowa 90° (BG) Ръкохватка ъглова 90°  
 (CZ) Madlo lomené 90° (EN) Angular rail 90°  
 (HU) Hajlított kapaszkodó 90° (RO) Balustrada de unghi 90°  
 (RU) Поручень угловой 90° (SK) Držadlo lomené 90°  
 (UA) Кутувий поручень 90°

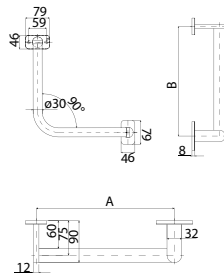

	<b>A</b>	<b>B</b>	
L30111071	300	300	
L30121171	300	600	(R)*
L30121271	300	600	(L)*

(R)\* - Права/ Дясна/ Pravé/ Right/ Jobbos/ Dreapta/ Правый/ Pravé/ Правий

(L)\* - Lewa/ Лева/ Levé/ Left/ Balos/ Stinga/ Левый/ L'avé/ Лівий

(PL) Poręcz prysznicowa (BG) Ръкохватка за душ  
 (CZ) Madlo do sprchy (EN) Shower handrail  
 (HU) Kapaszkodó zuhanyzóhoz (RO) Balustrada de dus  
 (RU) Поручень для душевой кабины (SK) Držadlo do sprchy  
 (UA) Поручень для душевої kabіни

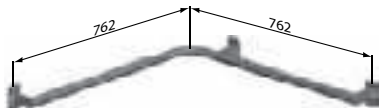

L30201071

(PL) Poręcz prysznicowa z zestawem natryskowym  
 (BG) Ръкохватка с поставка за душ (CZ) Madlo do sprchy  
 s držákem sprchy (EN) Shower handrail with shower head  
 holder (HU) Kapaszkodó zuhanyzóhoz zuhanyzókészlettel  
 (RO) Suștinere de duș cu jeturi (RU) Поручень  
 с держателем для душа (SK) Držadlo do sprchy  
 s držiakom sprchy (UA) Поручень з тримачем для душу

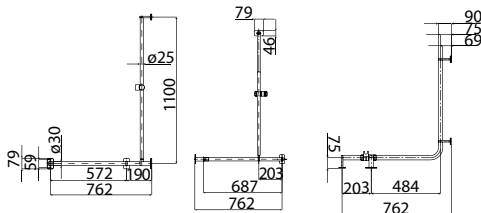

L30231171

(R)\*

L30231271

(L)\*

(R)\* - Prawa/ Дясна/ Pravé/ Right/ Jobbos/ Dreapta/ Правый/ Pravé/ Правий  
 (L)\* - Lewa/ Лява/ Levé/ Left/ Balos/ Stinga/ Левый/ Lavé/ Лівий



- (PL) Poręcz umywalkowa z uchwytem na ręcznik  
 (BG) Ръкохватка за умивалник с поставка за кърпи  
 (CZ) Madlo k umyvadlu s držákem na ručník (EN) Washbasin rail with towel holder (HU) Kapaszkodó mosdó mellé törülközőtartóval (RO) Suștinere chiuvetă cu suport prosop (RU) Поручень для умывальника с полотенцедержателем (SK) Držadlo pre umývadlo s držiakom na uterák (UA) Поручень для умивальника з тримачем для рушника

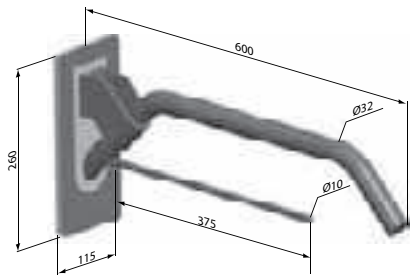

L30301001

- (PL) Poręcz uchylna (BG) Раздвижна ръкохватка  
 (CZ) Sklopné madlo (EN) Bow-type handrail (HU) Kihajtható kapaszkodó (RO) Suștinere înclinată (RU) Поручень откидной (SK) Sklopné držadlo (UA) Поручень відкидний

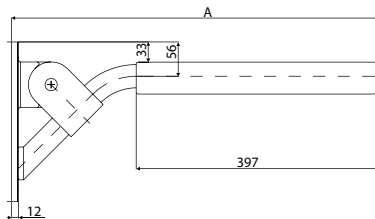

**A**

L30401001

600

L30402001

700

L30403001

850

(PL) Poręcz uchylna z uchwytem papieru toaletowego  
 (BG) Раздвижна ръкохватка с поставка за тоалетна хартия  
 (CZ) Sklopné madlo s držákem na toaletní papír (EN) Bow-type handrail, folding with toilet paper holder (HU) Kihajtható kapaszkodó toalettpapír-tartóval (RO) Susținere înclinată cu suport pentru hârtie igienică (RU) Поручень откидной с держателем для туалетной бумаги (SK) Sklopné držadlo s držiakom toaletného papiera (UA) Поручень відкидний з тримачем для туалетного паперу

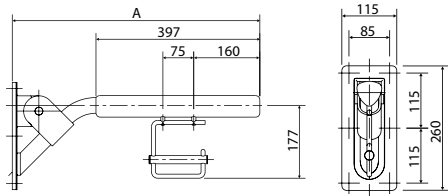

**A**

L30411001	600
L30412001	700
L30413001	850

(PL) Uchwyt papieru toaletowego (BG) Държател за тоалетна хартия със (CZ) Držák na toaletní papír (EN) Toilet paper roll holder (HU) Toalettpapír-tartó (RO) Suport hârtie igienică (RU) Держатель для туалетной бумаги (SK) Držiák toaletného papiera (UA) Тримач для туалетного паперу

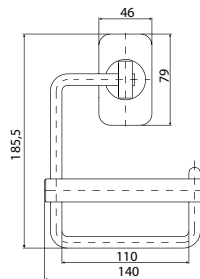

L31001001



PL Uchwyt szczotki toaletowej ze szczotką  
BG Тоалетна четка с поставка CZ Držák na klozetový  
kartáč vč. kartáče EN Toilet brush holder with toilet  
brush HU Toalettkefe-tartó kefével RO Mâner pentru  
perie de toaletă împreună cu peria RU Держатель  
для туалетной щетки со щеткой SK Držiak na WC  
kefu vč.kefy UA Тримач туалетної щітки зі щіткою

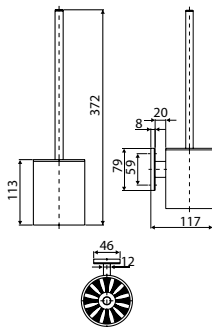

L31031001

- (PL) Siedzisko prysznicowe uchylne bez oparcia  
 (BG) Столче за душ сгъваемо за стенен монтаж  
 (CZ) Sklopné sedátko do sprchy bez opěrky  
 (EN) Folding shower seat without back (HU) Felhajtható zuhanyülöke, támla nélkül (RO) Scaun de dus reglabil, de instalat pe perete (RU) Сиденье для душа откидное без спинки (SK) Sklopné sedadlo do sprchy bez operadla (UA) Сидіння відкидне для душу без спинки

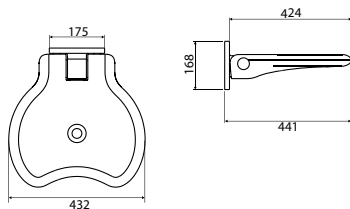

L32001001

- (PL) Siedzisko prysznicowe uchylne z oparciem (montaż naścienny) (BG) Душ седалка с облегалка (монтаж на стената) (CZ) Sklopné sedátko do sprchy s opěrkou (montáž na zeď) (EN) Folding shower seat with back (for wall mounting) (HU) Támlás lehajtható ülöke zuhanyzóhoz (falra szerelhető) (RO) Șezut pentru duș cu spătar (montare pe perete) (RU) Сиденье для душа откидное со спинкой (монтаж к стене) (SK) Sklopné sedadlo do sprchy s operadlom (montáž na stenu) (UA) Сидіння відкидне для душу зі спинкою

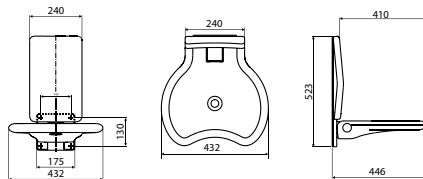

L32005001

